

Path: [Home](#) > [Enclosure Index](#) > Plastic Enclosures - Flame Retardant ABS



Beige



Black















Blue



















Grey

Key Features:

- Ideally suited for mounting printed circuit boards.
- Integral card guides accept 1.5 mm (0.062") P.C. cards.
- Lap joint construction provides protection against access of dust and splashing water.
- Designed to meet IP54.
- Molded from **flame retardant ABS plastic** (material carries a UL flammability rating of 94V-0).
- Link here to our more **economical version** (no inserts and molded in general purpose plastic).
- Lid is secured with M3 x 10 mm Philips machine screws, threaded into integral brass bushings. Perfect for applications with repetitive assembly and disassembly are required.
- Black enclosures include black screws, all others - standard nickel finish screws
-  Link here to **photo tables** of each part number (shown in grey)

Part Number	Color	Reader File	 Drawing File Size	AutoCAD .dwg Files (zipped)	.zip File Size	Units	Length	Width	Enclosure Depth (Less Lid)
1591MBG 1591MBK 1591MBU 1591MGY	Beige		64K		285K	Inches	3.3	2.2	0.8
	Black					mm	85	56	21
1591LBG 1591LBK 1591LBU 1591LGY	Beige		63K		212K	Inches	3.3	2.2	1.4
	Black					mm	85	56	35
1591ABG 1591ABK 1591ABU 1591AGY	Beige		71K		285K	Inches	3.9	2.0	0.8
	Black					mm	100	50	21
1591SBG 1591SBK 1591SBU 1591SGY	Beige		64K		276K	Inches	4.3	3.2	1.6
	Black					mm	110	82	40
1591BBG 1591BBK 1591BBU 1591BGY	Beige		71K		310K	Inches	4.4	2.4	1.1
	Black					mm	112	62	27

1591CBG 1591CBK 1591CBU 1591CGY	Beige Black Blue Grey		67K		215K	Inches	4.7	2.6	1.4
						mm	120	65	36
1591TBG 1591TBK 1591TBU 1591TGY	Beige Black Blue Grey		62K		219K	Inches	4.7	3.2	2.2
						mm	120	80	55
1591UBG 1591UBK 1591UBU 1591UGY	Beige Black Blue Grey		62K		284K	Inches	4.7	4.7	2.2
						mm	120	120	55
1591VBG 1591VBK 1591VBU 1591VGY	Beige Black Blue Grey		59K		218K	Inches	4.7	4.7	3.5
						mm	120	120	90
1591GBG 1591GBK 1591GBU 1591GGY	Beige Black Blue Grey		67K		327K	Inches	4.8	3.7	1.2
						mm	121	94	30
1591DBG 1591DBK 1591DBU 1591DGY	Beige Black Blue Grey		63K		238K	Inches	5.9	3.2	1.8
						mm	150	80	46
1591HBG 1591HBK 1591HBU 1591HGY	Beige Black Blue Grey		251K		331K	Inches	6.5	2.8	1.0
						mm	165	71	25
1591EBG 1591EBK 1591EBU 1591EGY	Beige Black Blue Grey		69K		256K	Inches	7.5	4.3	2.2
						mm	191	110	57



Link here to [photo tables](#) of each part number (shown in grey)

NOTES:

- All Dimensions in inches & mm
- Add 0.16" (4 mm) to enclosure depth for lid
- **Flame Retardant** ABS Plastic in Beige, Black, Blue or Grey

ABS Version Features:

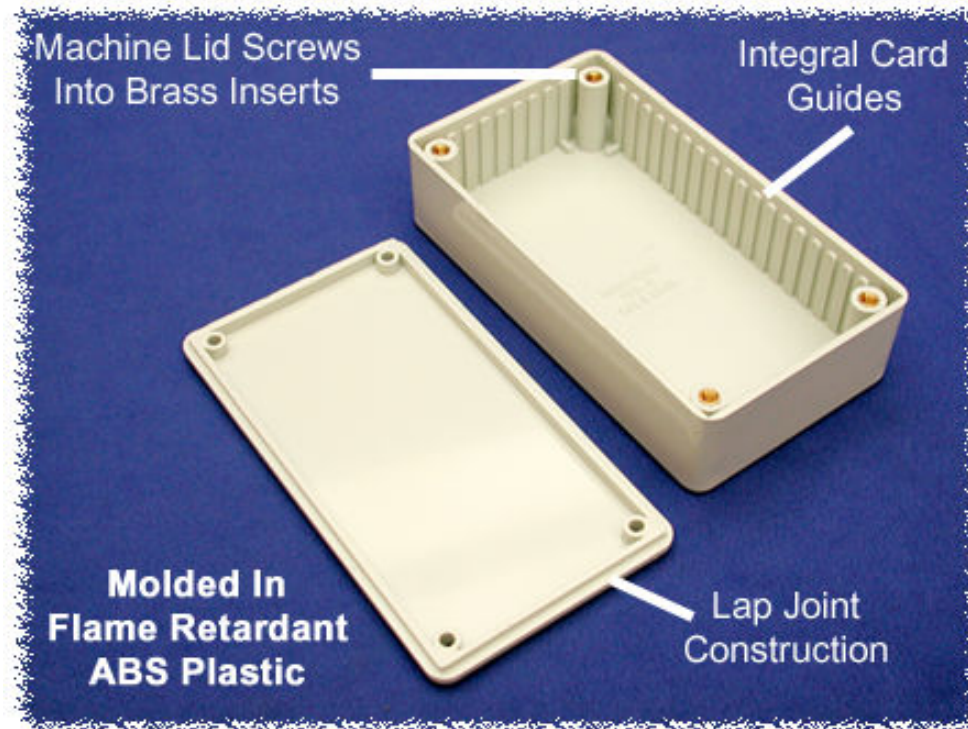

[DOWNLOAD](#)

catalog pages on this series (148K) [9C-1591.pdf](#)

Accessories

Flange Kits:

[Link Here For Details](#)

Top View



click to enlarge

Bottom View



click to enlarge

P.C. Board Card Adaptors:

Part Number **1591Z6** - Package of 6

Part Number **1591Z50** - Package of 50

Part Number **1591Z100** - Package of 100

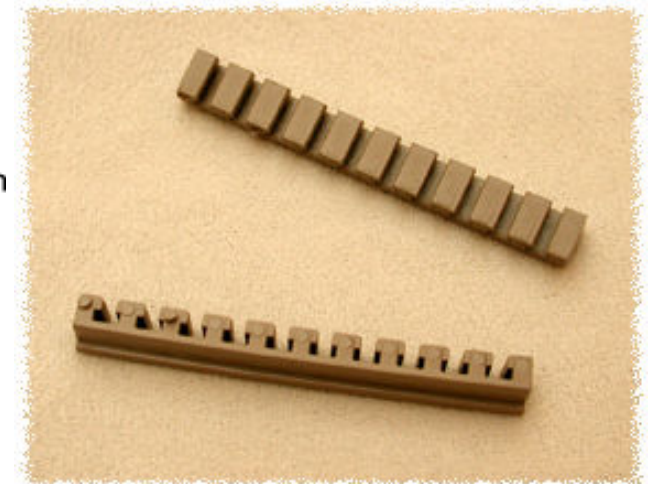
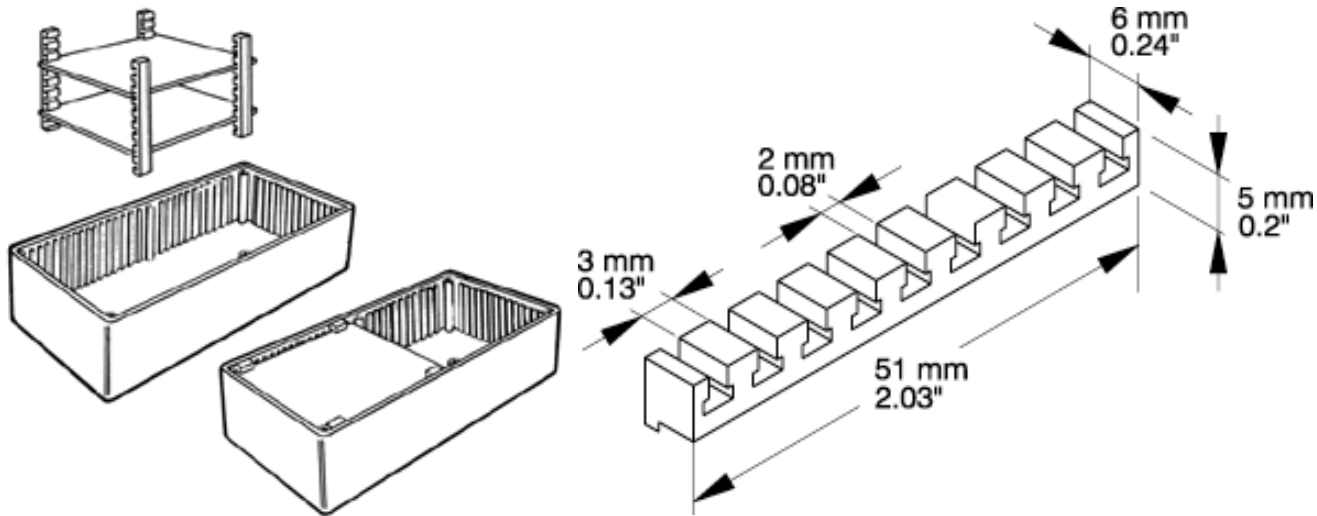

Replacement Screws:



Part Number **1591MS100**
Package of 100
M3 - 0.5 X 10mm



Part Number **1591MS100BK**
Package of 100
M3 - 0.5 X 10mm - Black

Belt or Pocket Clip:



- Molded from tough nylon.
- Includes 2 nylon screws (insulated to avoid internal interference).
- Mounting template included.

Black - Part Number **1599CLIP**
Grey (shown) - Part Number **1599CLIPGY**

Clear Lids:

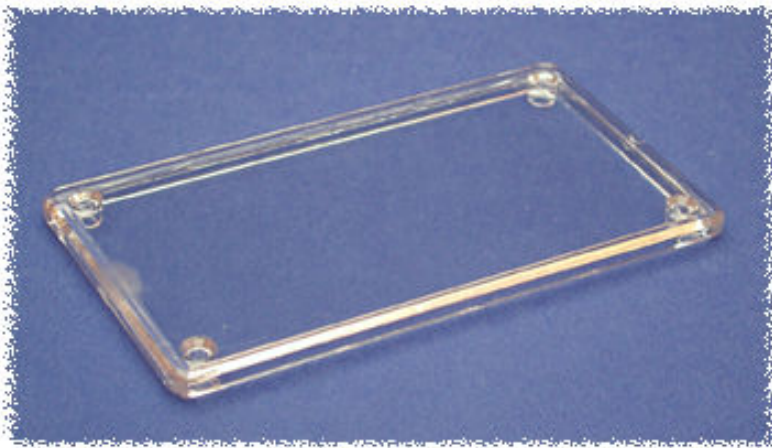

- Clear Polycarbonate - flame retardant material
- Enclosure is NOT included
- For clear lid and enclosure - see our [1591"T" series](#)

Part Number	Use With Enclosure Series
1591LC	1591L & 1591M
1591AC	1591A
1591BC	1591B
1591CC	1591C
1591DC	1591D
1591EC	1591E
1591GC	1591G
1591HC	1591H
1591SC	1591S
1591TC	1591T
1591UC	1591U
1591VC	1591V

Exactly what you are looking for???

Link to our stocking distributors - most have "on-line" pricing, stock check and ordering!!!

[Our Distributors](#)

Order from your favorite distributor

